

new

SERIE

TUNNEL54

FIRE PROOF



PUNCTURE
INSULATION
CONNECTION

TUNNEL FAN POWER
SUPPLY



Palazzoli











SYSTEMS FOR TUNNELS, ROAD TUNNELS AND MAJOR FIRE RISK PLACES

The products and their recommended applications

NICHE	VENTILATION	SIGNS	ORDINARY AND EMERGENCY LIGHTING
<p>Lighting Signalling and service devices power supply</p>	<p>Fans</p>	<p>Luminous panels Luminous stakes</p>	<p>Fluorescent lighting Line wire coupling Lighting unit branch line</p>
THERMOSETTING		THERMOSETTING	
 <p>TAIS IP67</p>		 <p>TAIS MIGNON IP67</p>	 <p>CEE IP67</p>
ALUMINIUM ALLOY			
	 <p>TUNNEL54 IP66</p>	 <p>TUNNEL54 IP66</p>	
STAINLESS STEEL		STAINLESS STEEL	
 <p>TUNNEL54 IP66</p>		 <p>TUNNEL54 IP66</p>	

SYSTEMS FOR TUNNELS, RAILWAY TUNNELS AND UNDERGROUNDS

The products and their recommended applications

TECHNICAL ROOMS	TUNNEL POWER SUPPLY SERVICE FACILITIES	STATION/ TUNNEL EMERGENCY	ORDINARY AND EMERGENCY LIGHTING
<p>Lighting and controls Service socket-outlets and junction boxes</p>	<p>Socket-outlets and junction boxes</p>	<p>Isolators/buttons</p>	<p>Fluorescent lighting Line wire coupling Lighting unit branch line</p>
THERMOSETTING			
 <p>TAIS MIGNON</p>	 <p>TAIS IP67</p>	 <p>PH</p>	 <p>CEE IP67</p>
ALUMINIUM ALLOY			
 <p>ALUPRES IP67</p>	 <p>TUNNEL54 IP66</p>	 <p>ALUPRES/CAM IP66</p>	 <p>TUNNEL54 IP66</p>
STAINLESS STEEL			STAINLESS STEEL
 <p>RINO IP66</p>			 <p>TUNNEL54 IP66</p>



TUNNEL54 series Fire Proof

High performance
power supply system
for tunnel fans
400°C/120 minutes



TECHNIQUE

The TUNNEL 54 series high-performance power supply system is made from fire-resistant, flame-retardant and rodent-proof material and built to ensure continuity of service even under fire conditions. The sockets are equipped with a safety isolator switch with steel mechanical interlock and lockable handle in aluminium with the addition of a position plug. The casing of the isolator switch and the contact holding disks are made of reinforced thermoset resin with high thickness, equipped with excellent stability characteristics of size, non-deformability, resistance to heat and fire, to the effects of weather and chemical agents and to mechanical stress even at low temperatures. The isolator switch contacts are double breakers with pads made of silver-nickel on busbars of nickel-plated brass. The control shaft is a monolithic-type busbar that enables direct contemporaneous operation of cam movement without mechanically interposed set wheels. The socket is complete with a grounding system with screw clamp type M6 outside the casing. The cable input, provided with supporting terminal block, allows the connection of

power lines, with single or three-pole cables of the FTG10(O)M1 type, directly up to the section of 35mm², and with additional box up to 95 mm². The sockets are indelibly and visibly marked FIRE PROOF with guarantee of passing tests at 400°C for 120 minutes. The body of the plug is also made of aluminium alloy EN 1706 AC-46100DF (formerly UNI5076), the contact hold is made from reinforced thermoset resin with high thickness. The handle of the lining of the plug body, with ergonomic shape, is made of aluminium alloy EN 1706 AC-46100DF (formerly UNI5076) to guarantee its functionality at 400°C for 120 minutes. Degree of protection IP66 according to IEC EN60529 (IEC 70-1), with mechanical protection index exceeding IK10 in conformity with EN50102 (IEC 70-3) standard. The input cable plug is made of a cable clamp with radial tightening in nickel-plated brass, sized to accommodate three-pole cables of the FTG10(O)M1 type up to a section of 16 mm².

THE ADVANTAGES



SAFETY

The isolator switch contacts are double breakers with pads made of silver-nickel alloy on busbars of nickel-plated brass. The control shaft is a monolithic-type busbar that enables direct contemporaneous operation of cam movement without mechanically interposed set wheels.



RELIABILITY

The socket body is made in aluminium alloy EN 1706 AC-46100DF (formerly UNI5076) in order to guarantee its functionality at 400°C for 120 minutes. Made of cylindrical sockets for nominal current up to 63A with a nominal voltage from 400V and 690V from 3P+± in accordance with CEI EN 60309-1 and CEI EN 60309-2 standards.

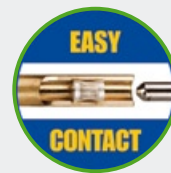

EXPERIENCE

The socket insert has a multi-lamellar crown in silver coated copper-beryllium alloy and guarantees: wider pit-plug surface contact; easy removal of the plugs from the socket-outlets; perfect cleaning of the plug and a hard-wearing, long-lasting electric contact.

TUNNEL54 series

PRODUCT SPECIFICATIONS

Conformity to standards:	CEI EN 50200 - CEI EN 50362 European Directive 2004/54/CE ANAS 7735 Memorandum Guidelines for safety planning in road tunnels
Degree of protection:	IP66
Impact resistance:	> IK 10
Switch category:	AC23A - AC3 according to the chart on page 7
Temperature resistance:	400°C for 120' 850°C for 90'
Homologations:	IMQ / INTEK / Fire Proof



TUNNEL54 SERIES
Interlocked compact socket-outlets for tunnel fans with entries for **single pole** cables.
IP66 > IK10 400°C for 120'

Rated voltage (A)	Frequency	Rated use voltage	Poles	Palazzoli code	Pack Q.ty
63	50-60Hz	380÷415V	3P+≐	151511	1
63	50-60Hz	600÷690V	3P+≐	151512	1

Equipment:

n. 1 63A 3P+≐ IP67 plug. Inclusive of cable glands.
External earth terminal.



TUNNEL54 SERIES
Reduction junction boxes for large diameter **single pole** cables
IP66 > IK10
400°C for 120' / 850°C for 90'

M40
(15-27)

Line cable sections (mm ²)	Terminal poles section	External dimensions (mm)	Cable gland line (mm ²)	Palazzoli code	Pack Q.ty
from 50 to 70	3x70mm ²	185x252x152	M32 (11-21)	151533	1
from 95 to 120	3x125mm ²	252x315x193	M40 (15-27)	151534	1
from 150 to 185	200mm ²	315x315x193	M40 (15-27)	151535	1

Characteristics:

Fittings for internal and external earth screws.
M40 output sized for 3x25 mm² or 3x16 mm² cables.
Code 151535 with cable glands installed on the F5 raised flange.



TUNNEL54 SERIES
Interlocked compact socket-outlets for tunnel fans with entries for **multi-pole** cables.
IP66 > IK10 400°C for 120'

Rated voltage (A)	Frequency	Rated use voltage	Poles	Palazzoli code	Pack Q.ty
63	50-60Hz	380÷415V	3P+≐	151513	1
63	50-60Hz	600÷690V	3P+≐	151514	1

Equipment:

n. 1 63A 3P+≐ IP67 plug. Inclusive of cable glands.
External earth terminal.



TUNNEL54 SERIES
Reduction junction boxes for large diameter **multi-pole** cables
IP66 > IK10
400°C for 120' / 850°C for 90'

M40
(15-27)

Line cable sections (mm ²)	Terminal poles section	External dimensions (mm)	Cable gland line (mm ²)	Palazzoli code	Pack Q.ty
50	3x70mm ²	185x252x152	M50 (22-35)	151531	1
70	3x70mm ²	185x252x152	M63 (35-48)	151532	1

Characteristics:

Fittings for internal and external earth screws.
M40 output sized for 3x25 mm² or 3x16 mm² cables.



TUNNEL54 SERIES
Rapid fastening supports of interlocked sockets for tunnel fans

Application	Palazzoli code	Pack Q.ty
Wall mounting bracket	151541	1
Rapid mounting on channel H 200mm	151542	1
Rapid mounting on channel H 300mm	151543	1
Mounting on support on channel	151544	1

Characteristics:

Stainless steel AISI 304.



TUNNEL54 SERIES
Interlocked high power
socket-outlets for tunnel fans
IP66 > IK10 400°C for 120'

Rated voltage (A)	Frequency	Rated use voltage	Poles	Palazzoli code	Pack Q.ty
63	50-60Hz	400÷690V	3P+≋	151880	1
125	50-60Hz	400÷690V	3P+≋	151881	1

Equipment:

equipped with gaskets and screws for fastening accessories.
Internal and external earth terminal.

Characteristics:

upper passage with F5 window.

Complementary items:

flanges with cable glands for closing and fastening brackets on page 6.

On request:

auxiliary contact for switch status signal.



TUNNEL54 SERIES
Pair of supports for fastening
interlocked socket-outlets for fans
to the ceiling

Manufacture material	Palazzoli code	Pack Q.ty
Stainless steel AISI 304	151900	1

Characteristics:

complete with adjustable coupling for mounting to ceiling with profile 50x30mm and socket fastening screws.



TUNNEL54 SERIES
Tunnel fan plugs
for tunnels
IP66 > IK10 400°C for 120'

Rated voltage (A)	Frequency	Rated use voltage	Poles	Palazzoli code	Pack Q.ty
63	50-60Hz	400÷690V	3P+≋	151890	1
125	50-60Hz	400÷690V	3P+≋	151891	1

Characteristics:

1"1/8 cable gland for Ø 22mm ÷ 26mm cable tightening.

TUNNEL54 SERIES
Glazing enclosures for
fan power supply lines IP66 > IK10
400°C for 120' / 850°C for 90'

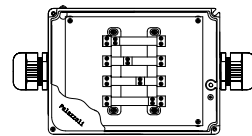

Line cable sections (mm²)	Pole/section terminals	External dimensions (mm)	Cable gland line (mm)	Palazzoli code	Pack Q.ty
3x10 - 3x16 3x25	3x25 mm²	185x185x105	M40 (19-28)	151553	1
3x35	3x40 mm²	252x185x152	M40 (19-28)	151564	1
3x50	3x70 mm²	252x185x152	M50 (26-35)	151575	1
3x70	3x70 mm²	252x185x152	M63 (34-45)	151585	1

Characteristics:

3-pin terminal block fixed on ceramic base with brass conductive bars and two screw non-loosening terminals.

No. 2 nickel-plated brass cable glands with ISO metric thread and cable radial fastening. M6 inside and outside earth terminal.

Complementary items:

Fastening brackets on page 12.



TUNNEL54 SERIES
 Raised closing flanges
 in aluminium alloy
 with brass cable glands
 for multi-pole cables
 IP67 >IK10
 400°C for 120' / 850°C for 90'

For windows	Cable gland line	Palazzoli code	Pack Q.ty
F5	M32 (11-21)	151930	1
F5	M40 (19-28)	151931	1
F5	M50 (26-35)	151932	1
F5	M63 (34-45)	151933	1



TUNNEL54 SERIES
 Raised closing flanges
 in aluminium alloy
 with brass cable glands
 for single pole cables
 IP67 >IK10
 400°C for 120' / 850°C for 90'

For windows	Cable gland line	Palazzoli code	Pack Q.ty
F5	n.3 x M25 (10-17)	151940	1
F5	n.3 x M32 (11-21)	151941	1
F5	n.3 x M40 (19-28)	151942	1



ALUPRES SERIES
 Raised closing flanges
 in aluminium alloy for
 enclosures with windowed walls
 IP67
 400°C for 120' / 850°C for 90'

For windows	Projection (mm)	Palazzoli code	Pack Q.ty
F5	80	540065	1

Uses:

they close unused windows. Make wiring easier as they increase the internal volume of the enclosure.

Selection table according to fan output

Code	Ie	Ue	Switch Category	Max Capacity
151511	63A	400V	AC23A - AC3	31kW
151513				
151512	63A	690V	AC23A - AC3	47kW
151514				
151880	63A	690V	AC23A - AC3	65kW
	63A	400V	AC23A - AC3	44kW
151881	125A	690V	AC23A - AC3	117kW
	125A	400V	AC23A - AC3	75W



TUNNEL54 series Fire Proof

Lighting systems for road, motorway, railway and metro tunnels



850°C x 90'
400°C x 120'

TECHNIQUE

Palazzoli designed TUNNEL54 series to solve in a rational and innovative way all the problems regarding electrified tunnels. The range is conceived in compliance with the New Guide Lines for the planning of Road Tunnel Safety, European Directive 2004/54/CE and the National laws in force. TUNNEL54 Series consists of flame-proof, smoke-proof, rodent-proof devices, in aluminium alloy or stainless steel, which guarantee constant service even in fire conditions, 400°C for 120' (prot. 7735) and 850°C for 90' (EN 50200) and are certified by reliable Laboratories at international level (IMQ, INTEK). As far as the lighting system, the product range goes from projectors for lanes and niches, junction enclosures for single pole and multi-pole cables with cable gland or socket-outlet output and glazing enclosures. What is important is the introduction of a puncture insulation connection, using a triple tooth device that

reduces the wiring time by 70% and allows energy use without sectioning the line.

Trademarks, symbols, awards

- *Gasket for wire cable entry*
4-35mm² IP66



THE ADVANTAGES



**Palazzoli
PATENTED**

INSULATING PERFORATION

The cable that is not prepared is inserted into the special insulating perforation terminal. Thanks to the calibrated breaking mechanism, the correct tightening torque guaranteeing electric contact is ensured.



**Palazzoli
PATENTED**

UNIVERSAL CABLE INPUTS

The electrical line enclosures with insulating perforation have universal cable inputs from 4 to 35mm². The protection rating is guaranteed for all permitted cable diameters.

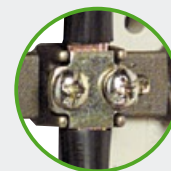

GUARANTEED CABLE PERFORMANCE

Unmatchable level of heat resistance of the brass terminal blocks on a ceramic base, connected to two screw non-loosening terminals, guarantee electrical continuity up to 850°C for 90'.



TUNNEL54 SERIES
Lighting fixtures in
stainless steel AISI 304 - glass
with **symmetrical aluminium**
reflector and fuse protection
230VAC/DC - IP65 Class II



TUNNEL54 SERIES
Lighting fixtures in
stainless steel AISI 304 - glass
with **asymmetrical aluminium**
reflector and fuse protection
230VAC/DC - IP65 Class II

Power (W)	Power supply	Lampholders and lamps	Palazzoli code	Pack Q.ty
2x18	electronic	G13 T8	152132	1
2x36	electronic	G13 T8	152232	1
2x58	electronic	G5 T5	152962	1

Power (W)	Power supply	Lampholders and lamps	Palazzoli code	Pack Q.ty
2x18	electronic	G13 T8	153132	1
2x36	electronic	G13 T8	153232	1
2x58	electronic	G5 T5	153962	1

Characteristics:

The lighting fixtures can be supplied in special execution complete with brackets for rapid fastening to channel and/or wired with cable and plug.

Example of usage





M20
(7-13)

TUNNEL54 SERIES
Electrical line enclosure
for single pole cables with
**puncture insulation
connections and cable gland**
IP67 >IK10
850°C for 90'

Line cable sections (mm²)	Class	External dimensions (mm)	Protections	Palazzoli code	Pack Q.ty
4-35	I	247x225x130	1 fuse 4A (L)	157011	1
4-35	I	247x225x130	2 fuses 4A (L+N)	157111	1
4-35	II	247x225x130	1 fuse 4A (L)	158011	1
4-35	II	247x225x130	2 fuses 4A (L+N)	158111	1



2P+±

TUNNEL54 SERIES
Electrical line enclosure
for single pole cables with
**puncture insulation connections
and IEC309 socket**
IP67 >IK10
850°C for 90'

Line cable sections (mm²)	Class	External dimensions (mm)	Protections	Palazzoli code	Pack Q.ty
4-35	I	247x254x130	1 fuse 4A (L)	157001	1
4-35	I	247x254x130	2 fuses 4A (L+N)	157101	1
4-35	II	247x254x130	1 fuse 4A (L)	158001	1
4-35	II	247x254x130	2 fuses 4A (L+N)	158101	1



M20 M20
(7-13) (7-13)

TUNNEL54 SERIES
Electrical line enclosure
for single pole cables with
**puncture insulation
connections and 2 cable glands**
IP67 >IK10
850°C for 90'

Line cable sections (mm²)	Class	External dimensions (mm)	Protections	Palazzoli code	Pack Q.ty
4-35	I	247x225x130	1 fuse 6A (L)	157012	1
4-35	I	247x225x130	2 fuses 6A (L+N)	157112	1
4-35	II	247x225x130	1 fuse 6A (L)	158012	1
4-35	II	247x225x130	2 fuses 6A (L+N)	158112	1



TUNNEL54 SERIES
Fixing supports for puncture
insulation junction enclosures

Manufacture material	Palazzoli code	Pack Q.ty
Stainless steel AISI 304	157050	1
Painted galvanised steel RAL 7035	157051	1

Equipment:

ideal in trunking with maximum height of 100 mm.

Example of usage

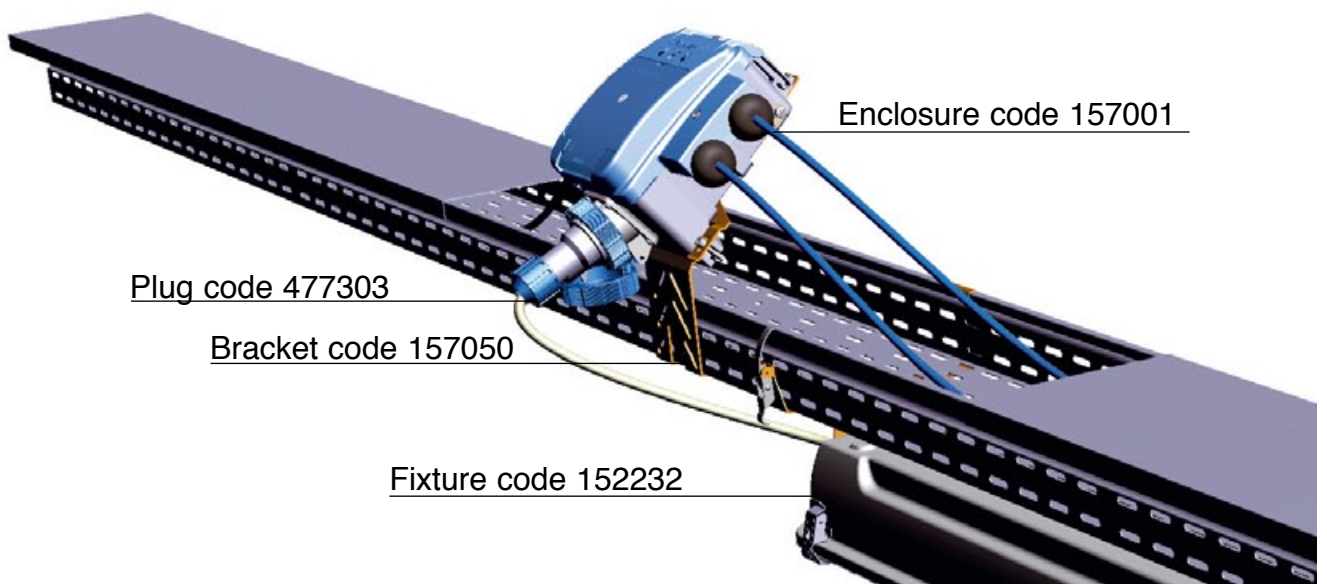

Enclosure code 157001

Plug code 477303

Bracket code 157050

Fixture code 152232



M25
(10-17)

TUNNEL54 SERIES
Enclosures for pass-through line for single pole cables for tunnel lightings, way out with cable gland IP66 - > IK10 850°C for 90'

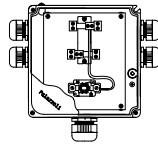

Line cable sections	Pole/section terminals	External dimensions (mm)	Cable gland line (mm)	Palazzoli code	Pack Q.ty
2x (1x4) mm ²	2x6 mm ²	185x185x105	M16	151011	1
2x (1x6) mm ²			(4,5-10)		
2x (1x10) mm ²	2x16 mm ²	185x185x105	M20	151022	1
2x (1x16) mm ²			(7-13)		
2x (1x25) mm ²	2x40 mm ²	185x252x152	M25	151034	1
2x (1x35) mm ²			(10-17)		
2x (1x50) mm ²	2x70 mm ²	252x315x193	M32	151045	1
2x (1x70) mm ²			(11-21)		

Equipment:
reduction flanges.



2P+ ±

TUNNEL54 SERIES
Enclosures for pass-through line for single pole cables for tunnel lightings, way out with industrial socket-outlet IP66 - > IK10 850°C for 90'

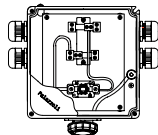

Line cable sections	Pole/section terminals	External dimensions (mm)	Cable gland line (mm)	Palazzoli code	Pack Q.ty
2x (1x4) mm ²	2x6 mm ²	185x185x105	M16	151311	1
2x (1x6) mm ²			(4,5-10)		
2x (1x10) mm ²	2x16 mm ²	185x185x105	M20	151322	1
2x (1x16) mm ²			(7-13)		
2x (1x25) mm ²	2x40 mm ²	185x252x152	M25	151334	1
2x (1x35) mm ²			(10-17)		
2x (1x50) mm ²	2x70 mm ²	252x315x193	M32	151345	1
2x (1x70) mm ²			(11-21)		

Characteristics: 2-pin terminal block fixed on ceramic base with brass conductive bars and two screw non-loosening terminals.

Nickel-plated brass cable glands with ISO metric thread and cable radial fastening. M6 inside and outside earth terminal. Protection of the power supply phase of the light body using an E14-D01 ceramic fuse-holder base complete with fuses.

The fuse base is prewired at junction box.

Way out with socket-outlet 16A – 2P+ ±.

The resistance at 850°C x 90' is applied to the enclosure.

Complementary items: fastening brackets on page 12.

Equipment: reduction flanges.



M25
(10-17)

TUNNEL54 SERIES
Enclosures for pass-through line for multi-pole cables for tunnel lightings, way out with cable gland IP66 - > IK10 850°C for 90'

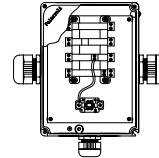

Line cable sections	Pole/section terminals	External dimensions (mm)	Cable gland line (mm)	Palazzoli code	Pack Q.ty
4x4 mm ²	4x6 mm ²	185x252x152	M32	151241	1
3G (2F+ ±) 4 mm ²			(11-21)		
4x6 mm ²					
3G (2F+ ±) 6 mm ²					
4x10 mm ²	4x16 mm ²	185x252x152	M32	151242	1
3G (2F+ ±) 10 mm ²			(11-21)		
4x16 mm ²	4x16 mm ²	185x252x152	M40	151252	1
3G (2F+ ±) 16 mm ²			(19-28)		
4x25 mm ²	4x40 mm ²	185x252x152	M40	151264	1
3G (2F+ ±) 25 mm ²			(19-28)		
4x35 mm ²					
3G (2F+ ±) 35 mm ²					
3x50+25 mm ²	4x70 mm ²	252x315x193	M50	151275	1
3G (2F+ ±) 50 mm ²			(26-35)		
3x70+35 mm ²					
3G (2F+ ±) 70 mm ²	4x70 mm ²	252x315x193	M63 (34-45)	151285	1

TUNNEL54 SERIES
Enclosures for pass-through line for tunnel lightings, way out with industrial socket-outlet IP66 - > IK10 850°C for 90'



2P+ ±

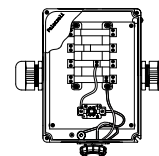

Line cable sections	Pole/section terminals	External dimensions (mm)	Cable gland line (mm)	Palazzoli code	Pack Q.ty
4x4 mm ²	4x6 mm ²	185x252x152	M32	151441	1
3G (2F+ ±) 4 mm ²			(11-21)		
4x6 mm ²					
3G (2F+ ±) 6 mm ²					
4x10 mm ²	4x16 mm ²	185x252x152	M32	151442	1
3G (2F+ ±) 10 mm ²			(11-21)		
4x16 mm ²	4x16 mm ²	185x252x152	M40	151452	1
3G (2F+ ±) 16 mm ²			(19-28)		
4x25 mm ²	4x40 mm ²	185x252x152	M40	151464	1
3G (2F+ ±) 25 mm ²			(19-28)		
4x35 mm ²					
3G (2F+ ±) 35 mm ²					
3x50+25 mm ²	4x70 mm ²	252x315x193	M50	151475	1
3G (2F+ ±) 50 mm ²			(26-35)		
3x70+35 mm ²					
3G (2F+ ±) 70 mm ²	4x70 mm ²	252x315x193	M63 (34-45)	151485	1

LIGHTINGS SYSTEMS



TUNNEL54 SERIES
Glazing enclosures for power supply lines for tunnel lightings
IP66 -> IK10
850°C for 90'

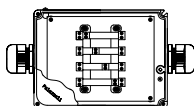

Line cable sections	Pole/section terminals	External dimensions (mm)	Cable gland line (mm)	Palazzoli code	Pack Q.ty
4x4 mm ²	4x6 mm ²	252x185x152	M32	151641	1
3G (2F+±) 4 mm ²			(11-21)		
4x6 mm ²					
3G (2F+±) 6 mm ²					
4x10 mm ²	4x16 mm ²	252x185x152	M32	151642	1
3G (2F+±) 10 mm ²			(11-21)		
4x16 mm ²	4x16 mm ²	252x185x152	M40	151652	1
3G (2F+±) 16 mm ²			(19-28)		
4x25 mm ²	4x40 mm ²	252x185x152	M40	151664	1
3G (2F+±) 25 mm ²			(19-28)		
4x35 mm ²					
3G (2F+±) 35 mm ²					
3x50+25 mm ²	4x70 mm ²	315x252x193	M50	151675	1
3G (2F+±) 50 mm ²			(26-35)		
3x70+35 mm ²					
3G (2F+±) 70 mm ²	4x70 mm ²	315x252x193	M63 (34-45)	151685	1

Characteristics:

4-pole terminal block fixed on ceramic base with brass conductive bars and two screw non-loosening terminals.

No. 2 nickel-plated brass cable glands with ISO metric thread and cable radial fastening.

M6 internal and external earth terminal.

UNI SERIES
Brass screwcaps with metric thread
IP68



Thread	Thread length (mm)	Palazzoli code	Pack Q.ty
M16x1.5	6	582316	100
M20x1.5	6	582320	100
M25x1.5	7	582325	100
M32x1,5	8	582332	50
M40x1,5	8	582340	25
M50x1.5	9	582350	25
M63x1.5	10	582363	10

Complementary items:

polygonal nuts on page 146 (general catalogue).

TUNNEL54 SERIES
Pair of supports for tunnel enclosures fastening



Manufacture material	For boxes dimensions	Palazzoli code	Pack Q.ty
Stainless steel AISI 304	185x185 / 252x185	151901	10
Stainless steel AISI 304	185x252 / 315x252	151902	10
Stainless steel AISI 304	252x315	151903	10

Equipment:

screws for enclosures fastening.

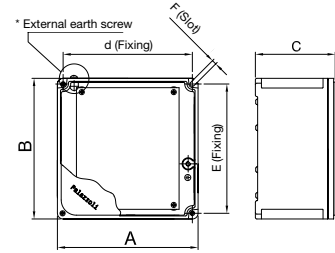
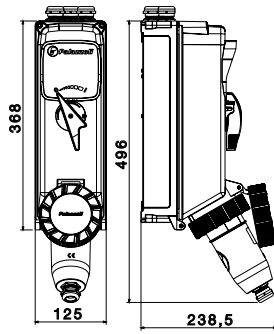
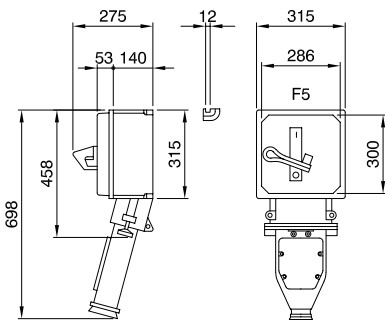

A (mm)	B (mm)	C (mm)	D (mm)	E (mm)	F (mm)	* screw
185	252	152	169	236	7	M6
252	315	193	224	300	9	M10
315	315	193	300	286	9	M10

TUNNEL series - 125A plugs and socket-outlets for tunnel fans

TUNNEL series - 63A plugs and socket-outlets for tunnel fans

**TUNNEL series
Reduction enclosures for cables IP66**

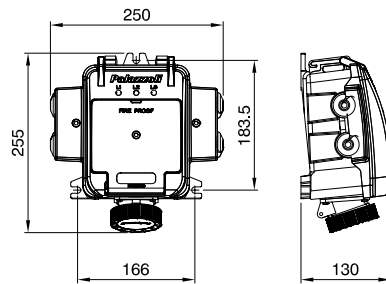
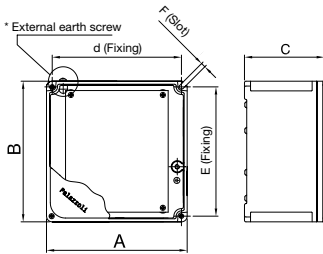

A (mm)	B (mm)	C (mm)	D (mm)	E (mm)	F (mm)	* screw
185	185	105	171	171	6	M6
252	185	152	236	169	7	M6
185	252	152	169	236	7	M6
252	315	193	224	300	9	M10
315	252	193	300	224	9	M10

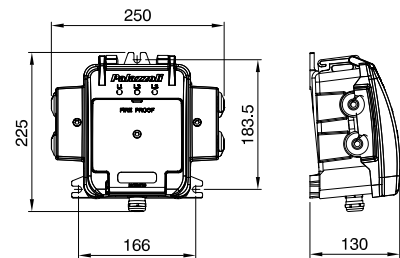
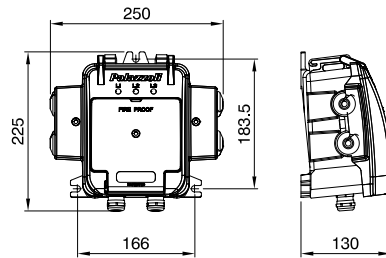

**TUNNEL series
enclosures for tunnels IP66**

**TUNNEL series
Puncture insulation enclosures IP66**

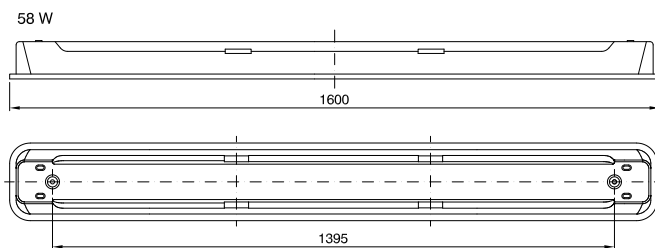
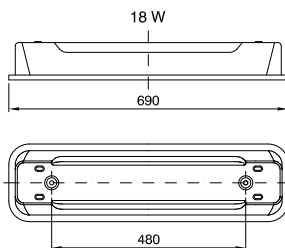
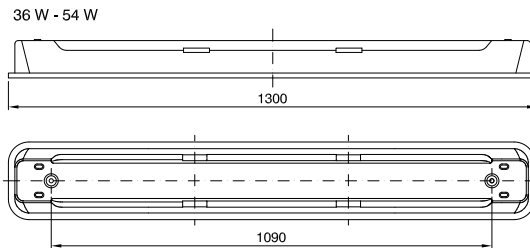
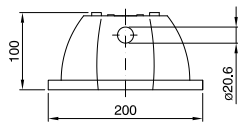

TUNNEL series - Tunnel lightings



REFERENCE STANDARD OVERVIEW

EC Directive **2004/54/EC** provides the minimum safety requirements for tunnels on the TEN - Trans European Road Network which exceed 500 metres in length. This Directive has been implemented by the Italian Law with **Legislative Decree dated October 5, 2006**, published in the **Italian Official Gazette n. 235**. In Italy the TEN network basically coincides with the motorway network, in addition to certain sections managed directly by ANAS, more precisely Sections E45, A3 SA-RC, GRA, SS20, SS33, A29, SS106 and SS76. In terms of safety, the Directive defines the minimum plant facility and infrastructural requirements that all currently active and future TEN tunnels must comply with, according to traffic and geometrical parameters. All currently active Italian tunnels must achieve conformance with such requirements by the year 2019. All aspects which are not covered by the TEN directives are regulated by **Ministerial Decree dated June 5, 2001**, "Functional and geometric road building standards". This decree imposes strict documental and safety measure obligations on all road owners and management bodies. Important references for Design Engineers are provided in **Legislative Decree 264/2006**: "Implementation of EC Directive 2004/54/EC concerning safety requirements for tunnels on the TEN - Trans European Road Network". The primary objective is to achieve a level of safety that prevents all situations which are hazardous to human beings, the environment and tunnel plant facilities.

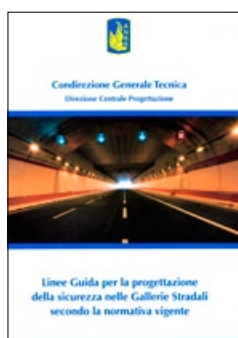

ANAS GUIDELINES

The **ANAS Engineering & Planning Division** has published its **Road Tunnel Safety Planning and Design Guidelines** taking into consideration all applicable national and international standards. Anas projects meet all modern road tunnel safety standard requirements. In particular, it implements all provisions foreseen by **Legislative Decree 264/2006** which, as mentioned, is applicable to the TEN network only. Not only has ANAS extended such regulations to all the tunnels it owns, but it has also increased the so-called minimum requirements; this results in a lower acceptable risk level and therefore a higher safety level.



ANAS and PALAZZOLI

Palazzoli has been working with ANAS for over 10 years in adopting all preventive measures to achieve a level of safety that prevents all situations which are hazardous to human beings, can jeopardize the environment and tunnel plant facilities.

More specifically, Palazzoli is the core element of the ANAS specifications for lighting and ventilation SYSTEMS.



ORDINARY LIGHTING *(extract from the ANAS Guidelines)*

"...Junction boxes providing power supplies to lighting fixtures in tunnels. The junction box must have a minimum protection rating of IP 65 in accordance with the CEI EN 60529 Standard with an impact resistance level of IK07. The housing must be fitted with a fuse-holder base which is pre-wired to the junction box, and able to provide adequate protection for the lighting fixture power supply phase. Earthing must be guaranteed by the use of terminals. Construction materials must be UNI 5076 standard aluminium alloys or INOX AISI 304 or 316L standard stainless steel. Lighting fixtures must be powered by 16A CEE 2P+E sockets with a protection rating of no less than IP 65..."

See pages 10-11 of this brochure.

EMERGENCY LIGHTING *(extract from the ANAS Guidelines)*

“...Junction boxes providing power supplies to emergency lighting fixtures
The junction box must have a protection rating of no less than IP 65 under CEI EN 60529 Standards, with an impact resistance level of IK07. Terminals must be suitable for use with FTG10(O)M1 – 0.6/1KV type cables (fire-proof according to EN 50200/EN 50362 Standard requirements). The housing is also fitted with a fuse-holder base which is pre-wired to the junction box, and able to provide adequate protection for the lighting fixture power supply phase.

Earthing must be guaranteed by the use of terminals. Construction materials must be EN 1706 AC-46100DF Standard special aluminium alloys or INOX AISI 304 or 316L Standard stainless steel, or other material with identical minimum performance rates. The lighting fixtures shall be powered by 16A CEE 2P+E sockets. The junction box must be certified by an Accredited Certification Body and guarantee at least 90 minutes functionality at 850°C according to EN 50362 Standard requirements. Insulating perforation connections may be installed with no main backbone cable interruptions...”

See pages 10-11 of this brochure.



VENTILATION SYSTEM POWER SUPPLY *(extract from the ANAS Guidelines)*

“... Fans installed in tunnels must be powered by interlocked socket outlets and plugs which will guarantee continuity of power supplies at 400°C for 120 minutes.

Sockets must have a rated voltage of 690V 3P+E.

The utilisation category at 690V is AC23A-AC3.

Earthing must be guaranteed by the use of terminals inside and outside the socket enclosure connected to the mains. The socket must be fitted with a mechanical interlocking device.

The protection rating must be no less than IP 65 according to CEI EN 60529 Standards, with an impact resistance level of IK07. The junction box must be certified by an Accredited Certification Body and guarantee at least 90 minutes functionality at 400°C. The fans must be connected to an emergency power supply system.

The ventilation subsystem command and control system must be connected to the safety power supply system. If the project foresees partial powering of the ventilation system using the emergency power supply, this will be subject to separate approval pursuant to a specific probabilistic risk analysis...”

See pages 5-6 of this brochure.



S E R I E
TUNNEL54
F I R E P R O O F



Palazzoli S.p.A.

Via F. Palazzoli, 31 - 25128 Brescia - Italia
tel. +39 030 2015.1 fax +39 030 2015258
www.palazzoli.com - export@palazzoli.com

