

Isolatori distanziatori e portasbarre

Spacing insulator and bar holders

 **STFRER**

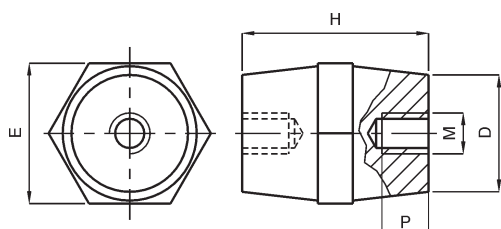



VITI SENZA TESTA CON ESAGONO INCASSATO FLUSH HEXAGON HEADLESS SCREW

H (mm)	M (mm)	Confezione Minimum Q.ty	CODICE CODE
14	3	100	9MVA0314G
14	4	100	9MVA0414G
25	5	100	9MVA0525G
20	6	100	9MVA0620G
25	8	100	9MVA0825G
35	10	100	9MVA1035G
40	12	100	9MVA1240G
50	16	100	9MVA1650G

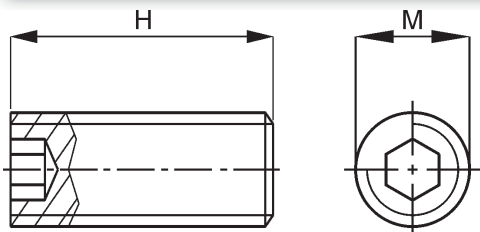

mat.acciaio / iron mat. UNI 5923-DIN 913

DATI PER L'ORDINAZIONE

– codice

ORDERING INFORMATION

– code

DATI TECNICI

materiale: massa poliestere
caricato con fibra di vetro
colore rosso
provvisti di inserti metallici
esenti da alogeni e silicone
temperatura di impiego
temperatura di distorsione
sotto carico
costante dielettrica
resistenza all' arco
assorbimento d' acqua
resistenza alla fiamma
norme di riferimento

TECHNICAL DATA

material: fiberglass
reinforced polyesther
red color
with threaded metal insert
halogen and silicone free
operating temperature
distortion temperature
under load
dielectric constant
arc resistance
water absorption
fire proof
relevant standards

RAL3002

M (ISO)

-40+130 °C

C° > 200

4 – 5

sec > 180

% < 0,3

V0

ASTM-UL / ISO – IEC 60439

H (mm)	E (mm)	M (mm)	D (mm)	P (mm)	Vn ac	Confezione Package		CODICE CODE	
						Nr./Q.ty	Kg		
12	10	3	10	3	125	100	0,3	SEP12103	
16	15	4	12	4	500	100	1	SEP16154	
		5						SEP16155	
20	19	4	15	6	750	105	1,2	SEP20194	
		5						SEP20195	
		6						SEP20196	
		6						SEP25224	
25	22	4	18	7	1000	100	2	SEP25225	
		5						SEP25226	
		6						SEP30306	
30	30	6	26	9	1200	100	10	SEP30308	
		8						SEP35326	
35	32	6	29	9	1400	120	9	SEP35328	
		8		10				SEP35320	
		10		9				SEP35416	
	41	6	35	9		80	7,8	SEP35418	
		8		10				SEP35410	
		10		9				SEP40416	
40	41	6	34	10	1600	60	7,5	SEP40418	
		8						10	SEP40410
		10						9	SEP4041D
	46	8	40	10		1600	48	9,2	SEP40468
		10							SEP40460
		12							SEP4046D
45	46	8	38	15	1800	50	7	SEP45468	
		10						SEP45460	
		12						SEP50366	
50	36	6	30	15	2000	80	8	SEP50368	
		8						10	SEP50360
		10						8	SEP50508
	50	8	40	15		2000	40	6,5	SEP50500
		10							SEP5050D
		12							SEP60558
60	55	8	43	15	2400	24	6,5	SEP6055D	
		12		20				SEP60600	
	60	10	50	15				SEP6060D	
		12		17				SEP65418	
65	41	8	32	15	2500	36	9	SEP65410	
		10		20				SEP6541D	
		12		15				SEP70608	
70	60	8	48	15	3000	15	6	SEP70600	
		10		20				SEP7060D	
		12		25				SEP7060S	
		16		15				SEP75508	
75	50	8	38	15	3200	25	7,5	SEP75500	
		10		20				SEP7550D	
		12		25				SEP80650	
80	65	10	52	20	3500	12	5,5	SEP8065D	
		12		25				SEP8065S	
		16		20				SEPC0650	
		10		20				SEPC065D	
100	65	12	52	25	5000	9	5	SEPC065S	
		16						SEPC065S	

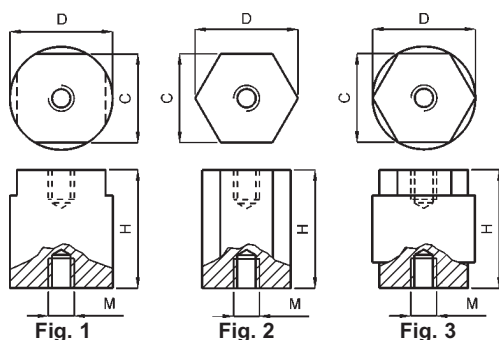

VITI SENZA TESTA CON ESAGONO INCASSATO FLUSH HEXAGON HEADLESS SCREW

H (mm)	M (mm)	Confezione Minimum Q.ty	CODICE CODE
14	3	100	9MVA0314G
14	4	100	9MVA0414G
25	5	100	9MVA0525G
20	6	100	9MVA0620G
25	8	100	9MVA0825G
35	10	100	9MVA1035G
40	12	100	9MVA1240G
50	16	100	9MVA1650G

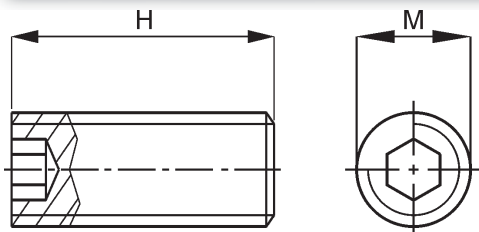

mat.acciaio / iron mat. UNI 5923-DIN 913

DATI PER L'ORDINAZIONE

– codice

ORDERING INFORMATION

– code

DATI TECNICI

materiale: massa poliestere
caricato con fibra di vetro
colore rosso
provvisti di inserti metallici
esenti da alogeni e silicone
temperatura di impiego
temperatura di distorsione
sotto carico
costante dielettrica
resistenza all' arco
assorbimento d' acqua
resistenza alla fiamma
norme di riferimento

TECHNICAL DATA

material: fiberglass
reinforced polyesther
red color
with threaded metal insert
halogen and silicone free
operating temperature
distortion temperature
under load
dielectric constant
arc resistance
water absorption
fire proof
relevant standards

RAL3002

M (ISO)

-40+130 °C

C° > 200

4 – 5

sec > 180

% < 0,3

V0

ASTM-UL / ISO – IEC 60439

Fig.	H (mm)	C (mm)	M (mm)	D (mm)	Vn ac	Confezione Package		CODICE CODE							
						Nr./Q.ty	Kg								
1	16	10	3	12	500	100	1,2	SCP16103							
			4					SCP16104							
	20	10	4	12	600	100	1,4	SCP20104							
			5					SCP20105							
3	25	10	4	12	600	100	1,7	SCP25104							
			5					SCP25105							
			6					SCP25186							
1	30	18	8	20	600	100	3	SCP25188							
			8					SCP25188							
2	30	18	4	12	600	100	2,1	SCP30104							
			6					SCP30176							
			8	20				700	5	SCP30186					
			8							SCP30188					
3	35	18	6	20	600	100	3			SCP30276					
			8							SCP30278					
1	40	18	6	20	600	100	2,4	SCP35105							
			8					SCP35186							
			27	30				700	140	9	SCP35188				
											8	SCP35276			
	3	40	27	6	30	900	140	10	SCP35278						
				8					SCP40186						
				36	40				1000	80	9	SCP40188			
												10	SCP40276		
				45	18				6	20	600	100	3,2	SCP40278	
														8	SCP40368
3	50	18	6	20	750	100	3,5	SCP40360							
			8					SCP45186							
			27	30				900	120	9,5	SCP45188				
											8	SCP45276			
	60	36	10	6	40	1000	60	7	SCP45278						
				8					SCP45368						
				50	18				6	20	750	100	3,5	SCP45360	
														8	SCP50186
				60	27				6	30	900	120	9,5	SCP50188	
														8	SCP50276
				60	36				10	6	40	1000	60	7,5	SCP50278
										8					SCP50368
50	18	6	20			750	100	3,5		SCP50360					
										8	SCP60186				
60	36	10	6	40	1200	50	7,5	SCP60188							
			8					SCP60188							
			50	18				6	20	750	100	3,5	SCP60276		
													8	SCP60276	
60	27	6	30	900	120	9,5	SCP60278								
							8	SCP60368							
60	36	10	6	40	1000	60	7,5	SCP60368							
			8					SCP60360							

SBVB - SBPS

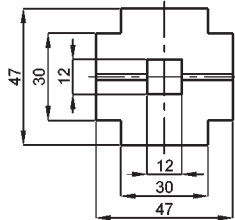
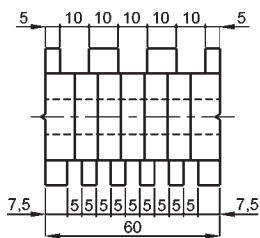
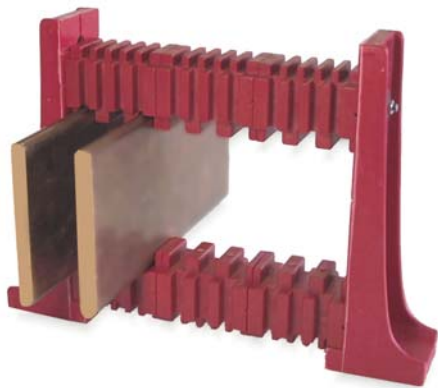

SBVB

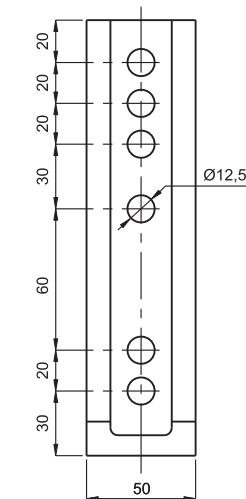
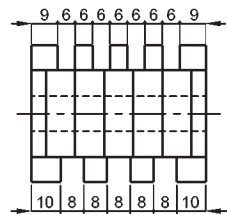

SBPS

DATI PER L'ORDINAZIONE

– codice

ORDERING INFORMATION

– code

BLOCCHETTI PORTASBARRE UNIVERSALI UNIVERSAL BAR - HOLDER BLOCKS

DATI TECNICI

materiale: policarbonato rinforzato con fibra di vetro
colore rosso
esenti da alogeni
resistenza all'urto
densità
resistenza a trazione
resistenza a compressione
assorbimento d'acqua
resistenza alla fiamma
resistenza a flessione
T° di esercizio continuo
rigidità dielettrica
resistenza alle correnti striscianti
norme di riferimento
Tensione di esercizio max

TECHNICAL DATA

material: fiberglass reinforced polycarbonate
red color
halogen free
impact strength
density
tensile strength
crushing strength
water absorption
fire proof
stiffness
continuous operating temperature
dielectric strength
creepage
relevant standards
max operating voltage

RAL3002
kJ/m² >90
g/cm³ 1.4
MN/m² >140
MN/m² >69
% < 0,2
V0
MN/m² >200
C° + 135
MV/m 21
V > 150
ASTM-UL / ISO – IEC 60439
1000V

CODICE CODE	Confezione Minimum Q.ty	Spessore sbarre Busbar thickness	N° Cave per blocchetto Nr. of slots for block	Altezza min. sbarre Min. busbar height	Resistenza agli sforzi elettrodinamici Electrodynamic strength
SBVB	30	5	5	2 mm	8 kN (±10%)
		6	4		10 kN (±10%)
		8	3	25 mm	12 kN (±10%)
		10	3		14 kN (±10%)
SBPS	12	Spalla di fissaggio - Fixing shoulder			

DESCRIZIONE

I blocchetti portasbarre universali dispongono di quattro facce differenti che ne consentono, utilizzando quella appropriata, l'uso con sbarre di spessore 5, 6, 8 o 10mm. Le spalle di fissaggio, costruite in poliestere rinforzato con fibra di vetro, permettono di supportare sbarre di altezza 30, 50, 60, 80, 100 e 120mm.

DESCRIPTION

The universal modular bar – holders have 4 different sides to be chosen according to the bar thickness (5, 6, 8, or 10 mm). The fixing shoulders in polyester reinforced with fiberglass support bars up to 30, 50, 60, 80, 100 and 120 mm high.

DISTANZA TRA I SUPPORTI - DISTANCE BETWEEN HOLDERS

Sbarre per fase - Bar per phase (interasse - interaxis 120mm)		Correnti di corto circuito efficaci R.M.S. short circuit currents								
Nr.	Dim. (mm)	12kA	20kA	30kA	40kA	50kA	60kA	70kA	75kA	80kA
4	30x5	740	440	280	210	165				
4	50x5	1160	645	410	305	245	195			
4	60x5	1420	745	475	350	285	225	190		
4	80x5	1980	945	590	440	355	280	240	225	210
4	100x5	2600	1160	700	525	420	330	285	265	250
4	120x5	3280	1450	810	300	480	380	325	300	285
4	30x6	930	560	355	265	210	170			
4	50x6	1530	810	515	380	310	240	210	195	
4	60x6	1880	930	590	440	350	280	240	225	210
4	80x6		1200	725	540	435	345	295	270	260
4	100x6		1500	855	640	510	405	345	320	305
4	120x6		1800	1000	735	590	430	395	370	350
3	30x8	1180	700	440	330	265	210	180		
3	50x8	1900	980	630	470	375	300	255	240	225
3	60x8	2300	1120	710	535	425	340	290	270	255
3	80x8		1450	870	650	520	415	355	330	310
3	100x8		1800	1030	765	610	470	415	390	365
3	120x8		2250	1230	880	700	480	460	445	420
3	30x10	1700	930	590	445	355	285	240	225	210
3	50x10		1300	810	610	490	390	335	310	290
3	60x10		1500	920	690	550	440	375	350	330
3	80x10		2000	1120	840	670	535	455	425	400
3	100x10			1350	980	780	540	520	495	465
3	120x10			1630	1120	890	545	520	510	500

SPV... - MNSAP...

PORTASBARRE COMPONENTI A PETTINE MODULAR BAR-HOLDERS

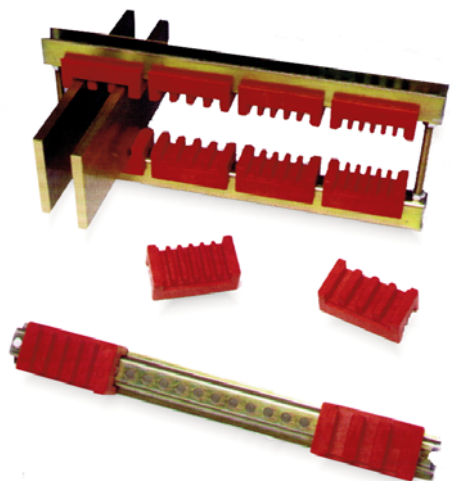

DATI TECNICI

materiale: policarbonato
rinforzato con fibra di vetro
colore rosso
esenti da alogeni
resistenza all'urto
densità
resistenza a trazione
resistenza a compressione
assorbimento d' acqua
resistenza alla fiamma
resistenza a flessione
T° di esercizio continuo
rigidità dielettrica
resistenza alle correnti striscianti
norme di riferimento
Tensione di esercizio max

TECHNICAL DATA

material: fiberglass
reinforced polycarbonate
red color
halogen free
impact strength
density
tensile strength
crushing strength
water absorption
fire proof
stiffness
continuous operating temperature
dielectric strength
creepage
relevant standards
max operating voltage

RAL3002

$\text{kJ/m}^2 > 90$
 $\text{g/cm}^3 1.4$
 $\text{MN/m}^2 > 140$
 $\text{MN/m}^2 > 69$
 $\% < 0,2$
V0
 $\text{MN/m}^2 > 200$
 $\text{C}^\circ + 135$
MV/m 21
 $V > 150$
ASTM-UL / ISO - IEC 60439
1000V

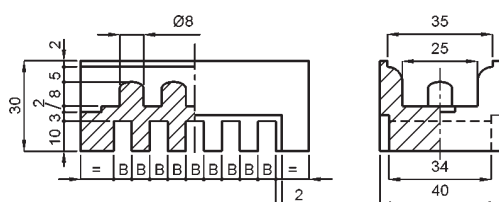

SPV...

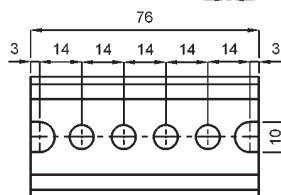

MNSAPSN

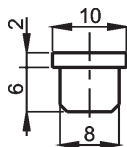

MNSAPSO

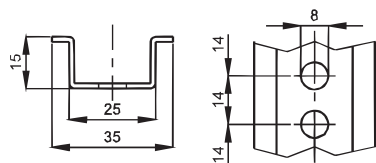

CODICE CODE	Confezione Minimum Q.ty	Spessore sbarre Busbar thickness	N° Cave per sbarre Nr. of slots for busbar	Altezza min. sbarre Min. busbar height	Resistenza agli sforzi elettrodinamici Electrodynamic strength
SPV05	50	5	6	25 mm	10 kN ($\pm 10\%$) con MNSAPSN
SPV08	50	8	4		
SPV10	50	10	3		
MNSAPSN	100	Spalla di fissaggio - Fixing shoulder			
MNSAPSO	10	Guida supporto (omega) 2mt - mt. 2 support rail (omega wise)			

SPV05, DISTANZA TRA I SUPPORTI - SPV05, DISTANCE BETWEEN HOLDERS

Sbarre per fase - Bar per phase (interasse - interaxis 112mm)		Correnti di corto circuito efficaci R.M.S. short circuit currents								
Nr.	Dim. (mm)	12kA	20kA	30kA	40kA	50kA	60kA	70kA	75kA	80kA
4	30x5	770	440	280	210	170				
4	40x5	950	550	350	260	205	165			
4	50x5	1160	650	410	310	245	195			
4	60x5	1420	750	475	355	285	225	195		
4	80x5	1950	940	585	440	350	280	240	220	210
4	100x5		1170	690	520	415	330	280	260	245
4	125x5		1500	830	615	490	390	330	310	290
4	30x6	900	560	355	265	210	170			
4	40x6	1200	680	435	325	260	210	175		
4	50x6	1500	810	515	385	310	245	210	195	
4	60x6	1850	920	585	440	350	280	240	220	205
4	80x6		1185	715	535	430	340	290	270	255
4	100x6		1500	845	630	505	400	345	320	300
4	125x6		1800	1045	750	595	475	405	380	355

SPV08-10, DISTANZA TRA I SUPPORTI - SPV08-10, DISTANCE BETWEEN HOLDERS

Sbarre per fase - Bar per phase (interasse - interaxis 120mm)		Correnti di corto circuito efficaci R.M.S. short circuit currents								
Nr.	Dim. (mm)	12kA	20kA	30kA	40kA	50kA	60kA	70kA	75kA	80kA
4	30x8	1450	820	520	385	315	250	215	200	185
4	40x8	1900	1000	635	475	380	300	260	240	225
4	50x8		1180	735	550	440	350	300	280	260
4	60x8		1380	830	625	500	395	340	315	295
4	80x8		1800	1010	750	605	480	410	385	360
4	100x8		2300	1185	880	710	565	480	450	420
4	120x8			1450	1050	830	660	565	520	480
3	30x10	1700	950	600	450	360	285	245	225	215
3	40x10	2200	1130	710	530	430	340	290	270	250
3	50x10		1310	820	620	490	390	335	315	295
3	60x10		1550	930	690	555	440	380	355	330
3	80x10		2010	1135	840	675	540	460	430	400
3	100x10			1400	990	790	630	540	500	470
3	120x10			1700	1150	930	730	540	530	525

DATI PER L'ORDINAZIONE

- codice

ORDERING INFORMATION

- code

CARATTERISTICHE ELETTRICHE E MECCANICHE ELECTRICAL AND MECHANICAL CHARACTERISTICS

SEP...

ISOLATORI DISTANZIATORI ESAGONALI
HEXAGONAL SPACING INSULATORS

CODICE CODE	Vn dc	Vt ac	Vt dc	Vtp	Kgf	Kgt	Nm						
SEP12103	150	750	1000	1200	40	75	1						
SEP16154	600	3000	4200	5500	100	150	3						
SEP16155													
SEP20194	900	5000	7000	9000	200	300	3						
SEP20195							6						
SEP20196							10						
SEP25224	1200	6000	8500	11000	180	400	3						
SEP25225							6						
SEP25226							10						
SEP30306	1500	8000	11000	14000	300	600	10						
SEP30308							25						
SEP35326	1600	9000	12500	16000	500	900	10						
SEP35328							25						
SEP35320							50						
SEP35416							10						
SEP35418							25						
SEP35410	50												
SEP40416	1900	10000	14000	18000	900	1100	10						
SEP40418							25						
SEP40410							50						
SEP4041D							85						
SEP40468							25						
SEP40460					50								
SEP4046D					85								
SEP45468					2100	11000	15500	20000	1000	1500	25		
SEP45460											50		
SEP4546D											85		
SEP50366	2400	12000	17000	21500							600	1000	10
SEP50368													25
SEP50360					50								
SEP50508		13000	18000	23500	1100	1800	25						
SEP50500							50						
SEP5050D						85							
SEP60558	2800	15000	21000	27000	1100	2200	25						
SEP6055D							85						
SEP60600							50						
SEP6060D					1200	2400	85						
SEP65418										25			
SEP65410	3000	16000	22000	29000	600	1000	50						
SEP6541D							85						
SEP70608							25						
SEP70600	3600	18000	25000	32500	1200	2500	50						
SEP7060D							85						
SEP7060S							200						
SEP75508	3800	20000	28000	36000	950	2400	25						
SEP75500							50						
SEP7550D							85						
SEP80650	4200	22000	31000	39500	1600	3000	50						
SEP8065D							85						
SEP8065S							200						
SEPC0650	6000	26000	36000	47000	1500	4000	50						
SEPC065D							85						
SEPC065S							200						

SCP...

ISOLATORI DISTANZIATORI A COLONNINA
STUD BOLTS SPACING INSULATORS

CODICE CODE	Vn dc	Vt ac	Vt dc	Vtp	Kgf	Kgt	Kgr
SCP25186	500	3000	5000	6000	200	400	1
SCP25188							
SCP30186	720	5000	7000	6600	200	400	1
SCP30188							
SCP30276		8000	11000		450	800	1,5
SCP30278							
SCP35186	720	5000	7000	6600	150	400	1
SCP35188							
SCP35276	900	8000	11000	8000	350	800	1,5
SCP35278							
SCP40186	720	8000	11000	6600	150	400	1
SCP40188							
SCP40276	900	9000	14000	8000	300	800	1,5
SCP40278							
SCP40368	1200	10000		11000	700	1000	3
SCP40360							
SCP45186	720	8000	11000	6600	100	400	1
SCP45188							
SCP45276	1200	10000	14000	11000	250	800	1,5
SCP45278							
SCP45368					600	1000	3
SCP45360							
SCP50186	900	10000	14000	8000	100	400	1
SCP50188							
SCP50276	1800	10000	14000	16500	200	800	1,5
SCP50278							
SCP50368					500	1000	3
SCP50360							
SCP60186	1000	10000	14000	9500	80	400	1
SCP60188							
SCP60276	1800	1500	21000	16500	150	800	1,5
SCP60278							
SCP60368					370	1000	3
SCP60360							

Vn = tensione nominale di esercizio (Volt)
Vn = *rated operating voltage (Volts)*
Vt = tensione nominale di tenuta (Volt)
(tens. scarica superficiale < tens. di scarica interna)
Vt = *rated withstanding voltage (Volts)*
Vtp = tensione di picco (Volt)
Vtp = *peak voltage (Volts)*
Nm = coppia di serraggio massima (Newtonmetro)
Nm = *max. tightening torque (Newtonmeter)*
Kgf = carico di rottura alla flessione (kg)
Kgf = *stiffness (kg)*
Kgt = carico di rottura alla trazione (kg)
Kgt = *tensile strenght (kg)*
Kgr = carico di rottura alla torsione (kg/m)
Kgr = *torque strenght (kg/m)*